

Plast-aid®

Multi-Purpose Repair Plastic

More Than Just A Glue™



PLA-1.5 \$17.07, PLA-6 \$29.95

Molecularly bonds to PVC, ABS, Lexan, CPVC and other plastics commonly used in pools and spas.



Available in two sizes
6 oz, and 1.5 oz.



Plast-aid* is a multi-purpose repair plastic used for thousands of repair solutions! Unlike anything on the market today, Plast-aid* forms a hard, durable, waterproof plastic in only 15 minutes!

Plast-aid* is a two part compound consisting of a liquid and powder. When combined, Plast-aid*'s unique curing process begins. As it thickens, Plast-aid* transforms from a castable liquid, to a glue, to a putty, to a clay, and finally to a hard, durable, waterproof plastic. This progression makes Plast-aid* an incredibly unique and versatile tool allowing it to be cast into molds, used to repair breaks and fill gaps, formed into shapes for custom parts, and much much more!



Plumbing

- »Unsurpassed for PVC plumbing repair! Don't cut out damaged PVC, simply & permanently patch it with Plast-aid* in only 15 minutes!
- »Make custom fittings & threaded adaptors.



Pool & Spa

- »Repair pools & spas, skimmers, holes, cracks, leaky PVC etc. in only 15 minutes!
- »Plast-aid* repairs are fast, waterproof & permanent.



Plast-aid* can be Colored & Made into Parts

- »Color Plast-aid* with artist acrylic or wood stain.
- »After Plast-aid* cures, drill, cut, file & polish your custom parts.

THIS STUFF IS AMAZING

YOU'VE GOT TO TRY IT

Talk about a "GREEN" product. Plast-aid* resurrects items normally declared "scrap"

* Plast-aid is patented and a registered trademark of Plast-aid Corporation

Eyeball Seat Wrench III

ESW-3 \$48.98



- Machined from a solid block of aluminum.
- Fits most 1 1/2" threaded eyeball seats made in the last 30 years.

Does not work with "Flush" eyeballs. For flush eyeball capability see our ESW-2

EYEBALL SEAT WRENCH

ESW-1 \$13.50

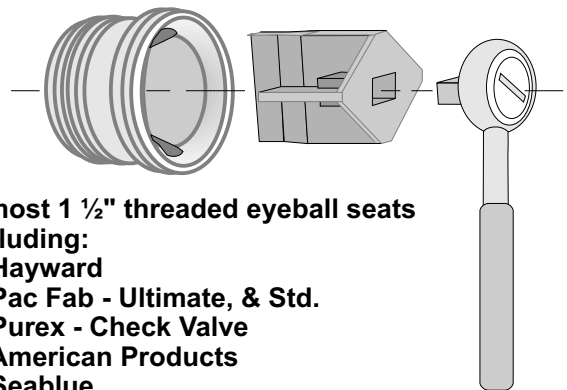

- Fits most 1 1/2" threaded eyeball seats Including:**
- Hayward
 - Pac Fab - Ultimate, & Std.
 - Purex - Check Valve
 - American Products
 - Seablue

Torque Provided by your standard 3/8" ratchet wrench or channel lock pliers.

Provides balanced torque when used as directed.

Strong PVC construction.



Pool Service Products

223 Altamonte Commerce Blvd. - Suite 1310
Altamonte Springs, FL 32714

gld2927

(407) 682-6900

(800) 683-4500

Fax (407) 682-2180